



design: nielsen innovation



handpresso®
premium quality espresso - anywhere!

EN FR IT ES DK DE NL



Welcome to the world of Handpresso!

Caring about quality and design, Handpresso invites you to discover a new coffee ceremony and to share this moment with friends. Handpresso Wild, an item boasting simple and pure lines, prepares an outstanding espresso, in an innovating way. All Handpresso creations use the E.S.E. (Easy Serving Espresso) standard, which ensures a premium quality in every cup you are serving, wherever you are. Handpresso Wild is so small and light that you can always bring it along. In its case, it can follow you at work, on weekends, on holidays, in the mountains or at sea. At home, it can be stored in a drawer or hung with your kitchenware. Pleasant to use, Handpresso Wild requires no descaling. We help you respect the environment in two ways: on the one hand, you generate yourself the energy required to brew your espresso, on the other hand, you do not leave your machine in stand-by mode. You reduce your energy consumption just as much.

This is all what Handpresso WILD offers. And much more!



⚠ Please read the warnings on p.13 before using your Handpresso machine

product description

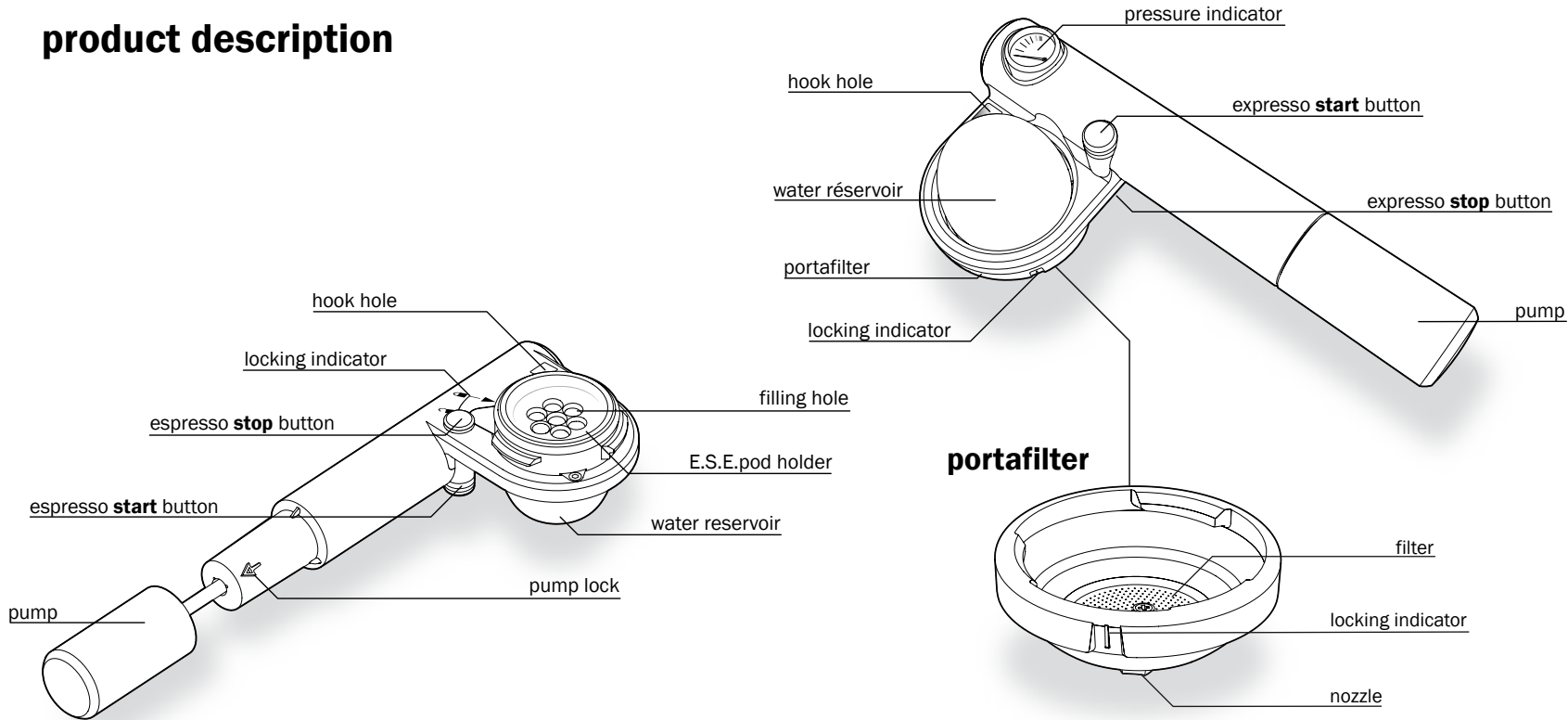

instructions

1

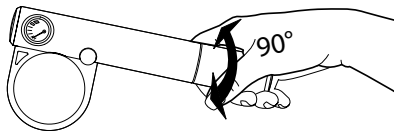

2

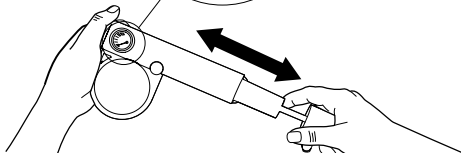
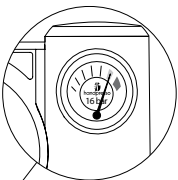

3

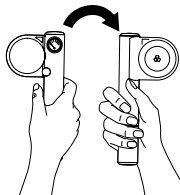

1 Unlock the pump by twisting the handle 90°.

2 Pump up to 16bar (green zone), and lock the pump by twisting the handle 90°.

⚠ Beware not to reach the red zone (over 16bar)!
To make pumping easier, place your hands as on the illustration opposite.

3 Turn round the machine so as to have the portafilter in front of you.

4 Remove the portafilter by unscrewing it 60° counter-clockwise.

5 Pour hot water in the reservoir, from a kettle or a thermo flask. **Pour the water slowly.**
Don't be surprised by the small capacity of the reservoir (50 ml).

6 Place an E.S.E. pod in the pod holder.

4

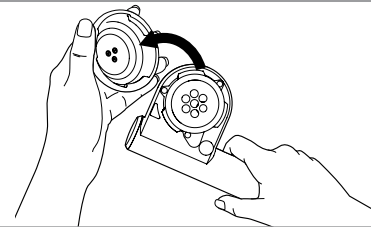

5

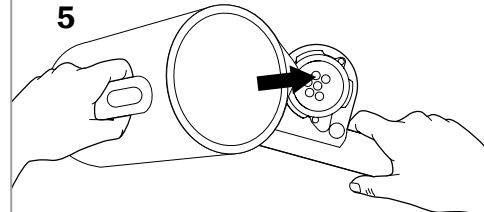

6

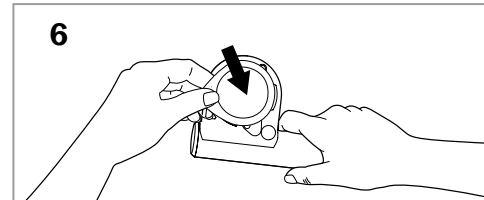

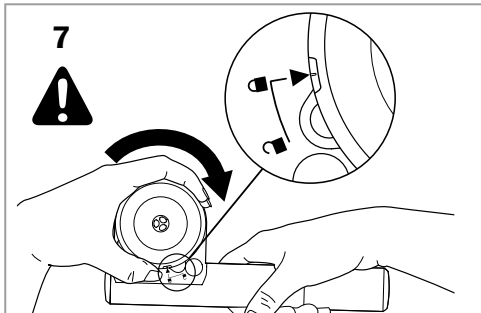

7 Place back the portafilter by turning clockwise 60° **up to the locking indicator**. Otherwise, the use of the machine could be dangerous!

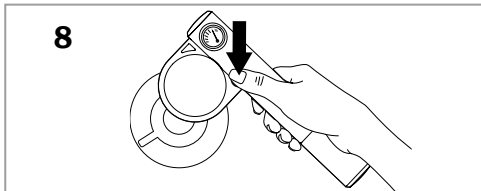

8 Flip the machine around. Push the start button and serve a premium quality espresso.

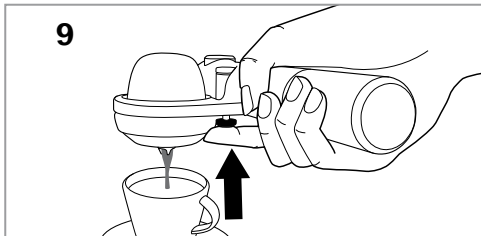

9 When the cup is filled as wished, stop the machine by **pushing the stop button** with the finger. The pressure of the machine is thereby released.

10 Turn round the machine and re-open it.
Always check that the stop button is pushed in before removing the portafilter!

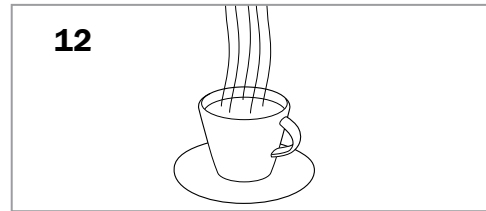
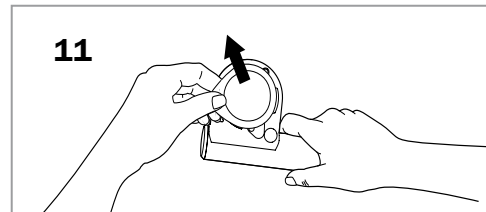
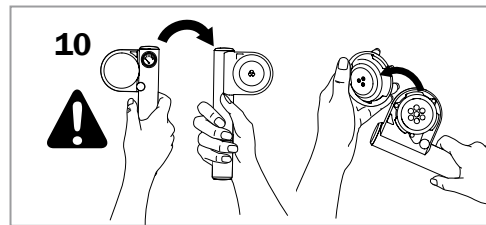

11 Remove and dispose of the E.S.E.pod.

12 Enjoy your espresso Handpresso Wild!



some useful recommendations

to get a premium quality espresso

- Always use good quality water.
- Only use E.S.E.pods (most recognized coffee brands propose E.S.E. pods).
- Take care of the temperature of the cups. We advise you to fill hot water in your cup before serving your coffee.
- If you like very strong coffee (Ristretto), Handpresso advises you to use the special ristretto portafilter (optional).
- For a premium quality, Handpresso proposes a range of accessories for your machine dedicated to mobility: thermo-flasks, carrying cases, etc.

cleaning and maintenance

- Always remove the brewed pods from the machine after use.
- Rinse your machine with water, and use a soft cloth to dry it. Do not use alcohol nor detergents to clean it. These liquids could change the characteristics of the machine and make it dangerous. Descaling your Handpresso Wild is unnecessary.
- Do not put it in the dishwasher nor in the microwave oven.
- Do not plunge in water.

storage

Owing to its small size, your Handpresso is easy to store:

- in a kitchen drawer,
- hung with your kitchenware (hook not provided),
- in its original box,
- in its carrying case (optional).

⚠ warnings ⚠

Please read the whole instructions before using the machine.

- Keep away from children & uninstructed persons. Avoid leaving the machine unwatched.
 - Make an eye inspection of the machine before using it and make sure that there is no crack, no deep scratch nor any other damage preventing it from being in working order.
 - Do not try to exceed the maximum pressure of 16 bar (green zone on the pressure indicator).
 - Only use E.S.E. pods.
 - Only pour water in the reservoir.
 - Never press the start button if the portafilter is not properly locked and **tightened up to the locking indicator**; step 7 in the instructions.
 - Do not try to remove the portafilter during usage and before having pushed the stop button.
 - Beware of coffee projections and beware of the direction of the nozzle during use.
 - If you get burnt, pour cold water immediately on the burnt area and call a doctor if necessary.
 - The machine should be used between 5°C and 50°C (41°F and 122°F), and under normal atmospheric pressure conditions (from 0 to 3000 m altitude).
 - Do not try to repair the machine or to replace parts yourself: contact an authorized retailer for this type of repair.
 - Do not use the machine for any other purpose.
- Handpresso would decline all responsibility in case of incorrect use.

repair

What to do in the following cases:

• **The pump is blocked & I cannot pump?**

Unlock the handle (step 1 in the instructions).

• **I pump, but the pressure does not rise?**

Check that the stop button is pushed in completely

Make sure to pump till the stop.

Contact the After Sale Service if the pressure still does not rise.

• **The water drips from the portafilter?**

Check the position of the rubber ring on the E.S.E. pod-holder.

Tighten the portafilter properly (step 7 in the instructions).

Replace the rubber ring if it is defect (dry, cracked, damaged or cut).

consumer service

Our consumer service is at your disposal to answer all your questions.

You can contact it by internet at:

www.handpresso.com.

technical data

water reservoir capacity.....	50ml
maximum pressure.....	16bar
dimensions L x w x h (mm).....	223 x 100 x 70
weight.....	576g

patents and trademarks

This machine is protected by international patent applications. Handpresso is a registered trademark.

E.S.E. is a registered trademark belonging to the E.S.E. consortium.

address

Handpresso
27 quai Franklin Roosevelt
77920 Samois sur Seine
FRANCE

www.handpresso.com

handpresso®
premium quality espresso - anywhere!



handpresso®
premium quality | espresso - anywhere!

www.handpresso.com